

# Game Central TV Stand

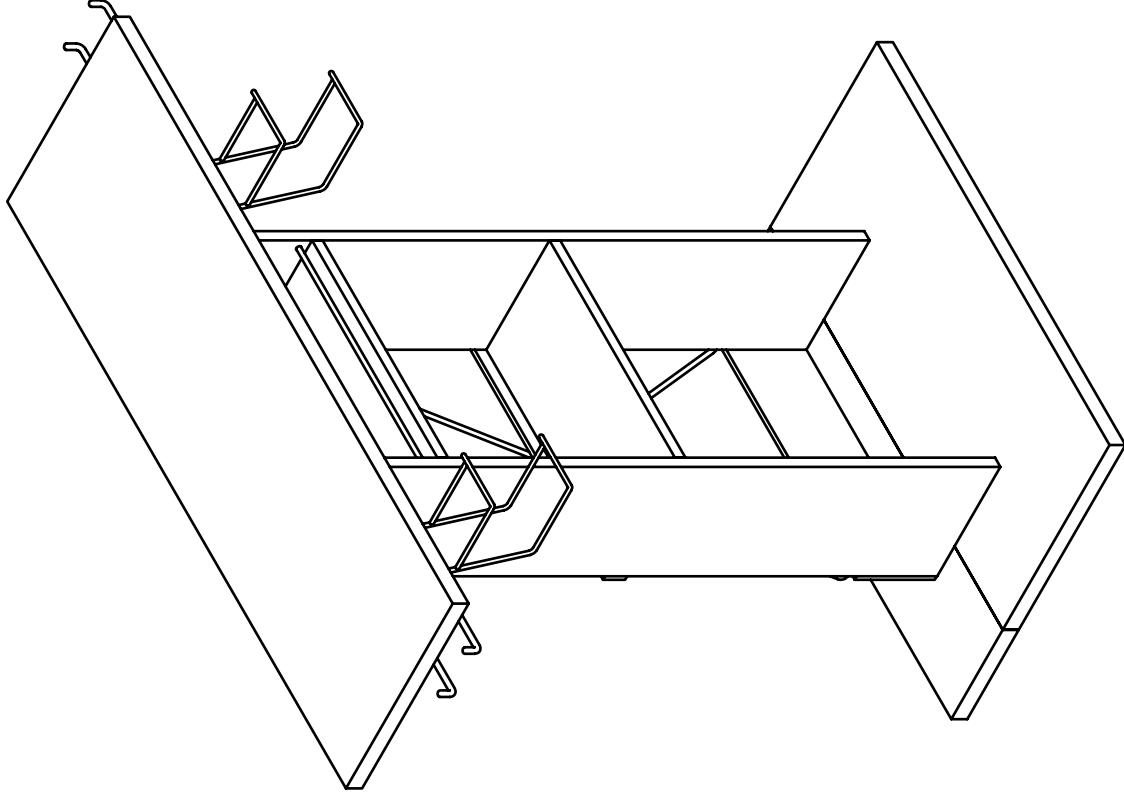







38 Game Storage

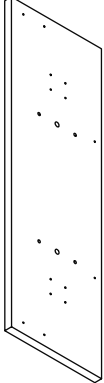
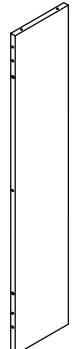

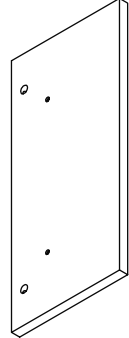
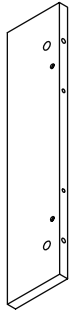
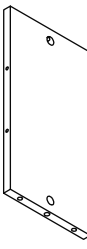
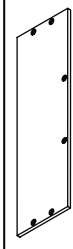



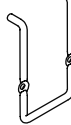
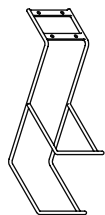
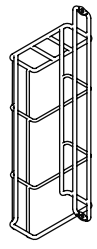

#38806135

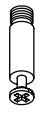
**ATLANTIC®**

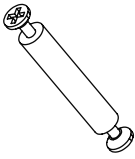
# Assembly Instruction / Directives d'assemblage / Instrucciones de ensamble:

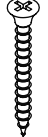
QTY / Cant. / Qté:	Parts List / Lista de Componentes / Liste des pièces:
1	
1	
1	
1	
1	
2	
1	
1	
1	
1	
2	
2	
1	
1	

QTY / Cant. / Qté:	Parts List / Lista de Componentes / Liste des pièces:
6	
6	
14	
4	
2	
28	
4	

Note
Tools needed/ not included Herramientas requeridas/ no incluidas Outils requis/ non fournis Phillips Screwdriver Desarmador de estrella (Phillips) Tournevis Phillips 

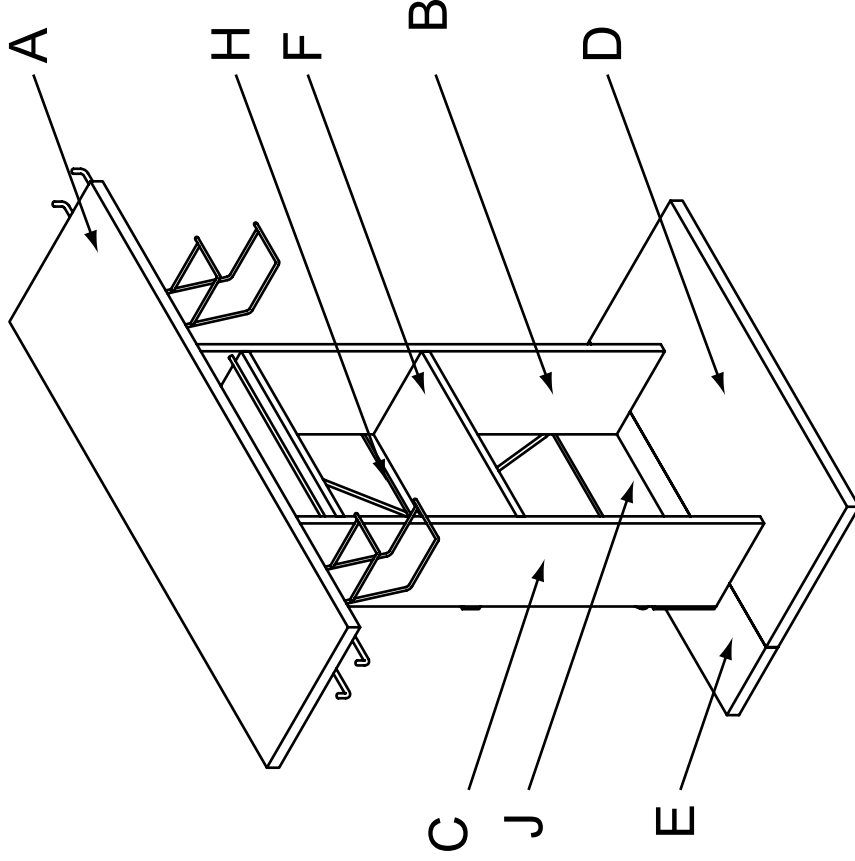

**ATLANTIC®**

©2011 Atlantic Inc.  
Santa Fe Springs, CA, U.S.A.  
U.S. AND OTHER FOREIGN PATENTS PENDING  
Patentes de los EUA y países extranjeros en trámite  
ALL RIGHTS RESERVED  
Derechos Reservados  
www.atlantic-inc.com  
MADE IN CHINA  
Hecho en China  
R 1.0 110319 #38806135

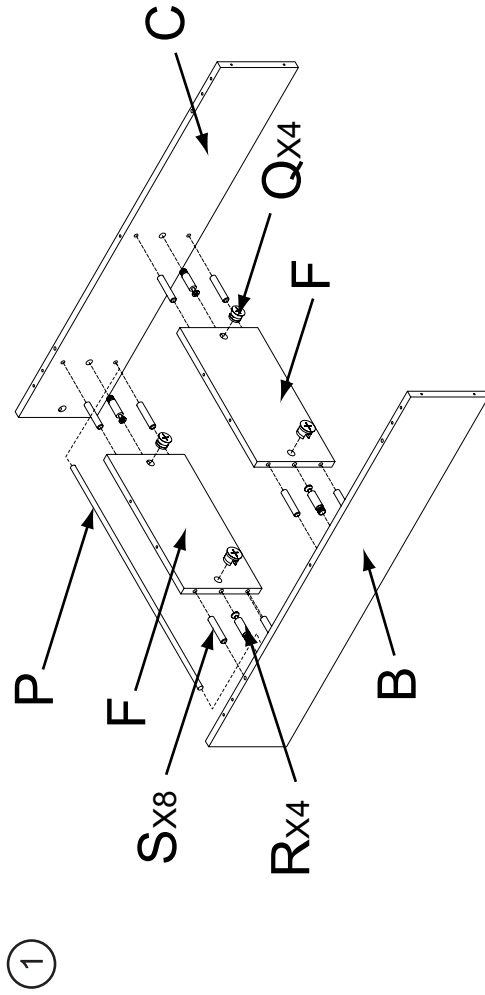

- 1- Insert wood dowels (S) and metal rod (P) into panel (B&C). Attach panels (B&C) to panel (F). Turn cam locks (Q) clockwise to secure.
- 1- Insérez les doigts en bois (S), les vis de came (R) et la tige en métal (P) dans le panneau (B&C). Attachez les panneaux (B&C) au panneau (F). Tournez les serrures de came (Q) dans le sens des aiguilles d'une montre pour fixer.
- 1- Inserte los pasadores de madera (S), los tornillos de la leva (R) y la barra de metal (P) en el panel (B&C). Ate los paneles (B&C) al panel (F). DÉ vuelta a las cerraduras de la leva (Q) a la derecha para asegurar.

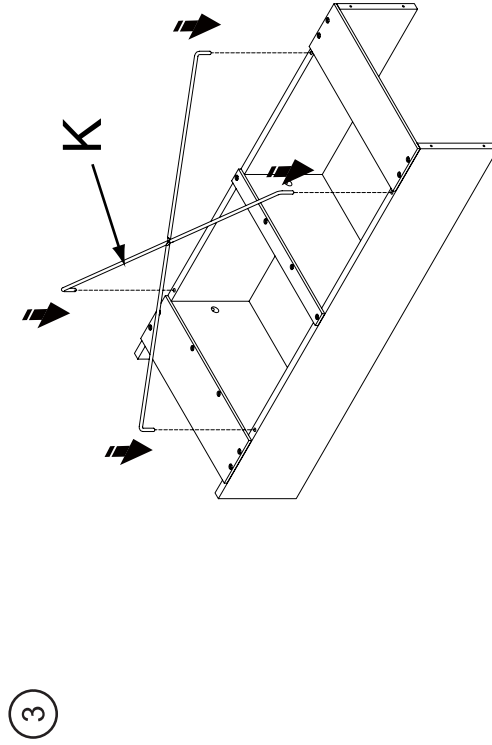

- 3- Place metal wire support (K) to the body.
- 3- Placez l'appui de fil en métal (K) au corps.
- 3- Ponga la ayuda del alambre de metal (K) al cuerpo.

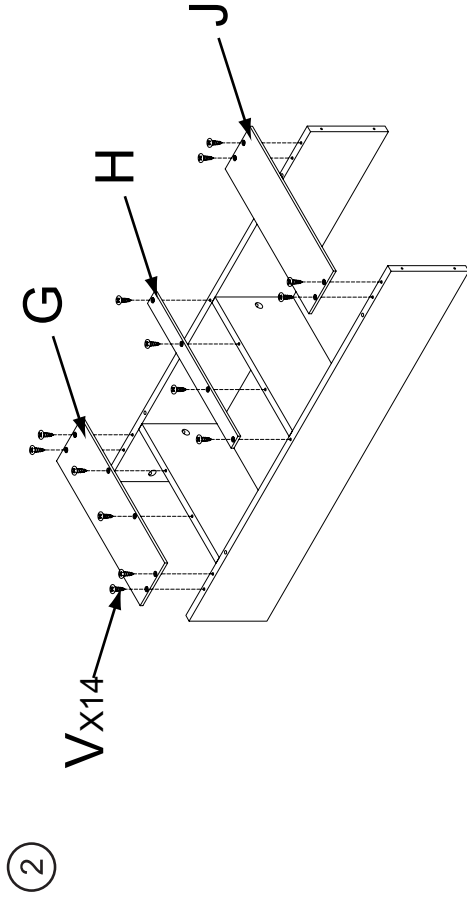

- 2- Fasten board (G,H&J) to the body using screws (V).
- 2- Attachez le panneau (G,H&J) au corps à l'aide des vis (V).
- 2- Sujete el tablero (G,H&J) al cuerpo que usa los tornillos (V).

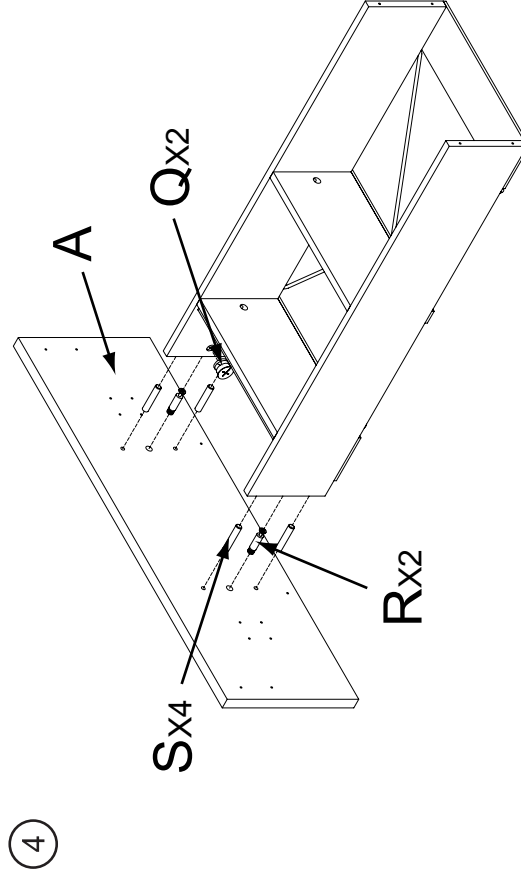

- 4- Insert wood dowels (S) and cam screws (R) into panel (A). Attach body to panel (A). Turn cam locks (Q) clockwise to secure.
- 4- Insérer bois dés (S) et cam vis (R) en panel (A). Joindre corps au panel (A). Tournez cam écloses (Q) dans le sens horaire pour sécuriser.
- 4- Inserte espigas de madera (S) y cam tornillos (R) en el panel (A). Asignamos cuerpo a grupo (A). Gire cerraduras de levas (Q) las agujas del reloj para garantizar.

5

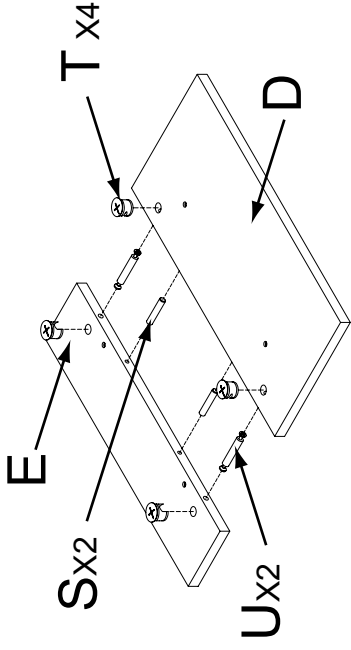

5-Insert wood dowels(S) and cam screws(U) into panel(E&D). Attach panel(E) to panel(D).

Turn cam locks(T) clockwise to secure.

5-Insert bois dés(S) et cam vis(U) en panel(E&D). Joindre panel(E) de panel(D).

Tournez cam écrous(T) dans le sens horaire d'obtenir.

5-Inserte espigas de madera(S) y cam tornillos(U) en el panel(E&D).

Atribuímos grupo(E) a la subcomisión(D). Gire cerraduras cam(T) las agujas del reloj para seguro.

6

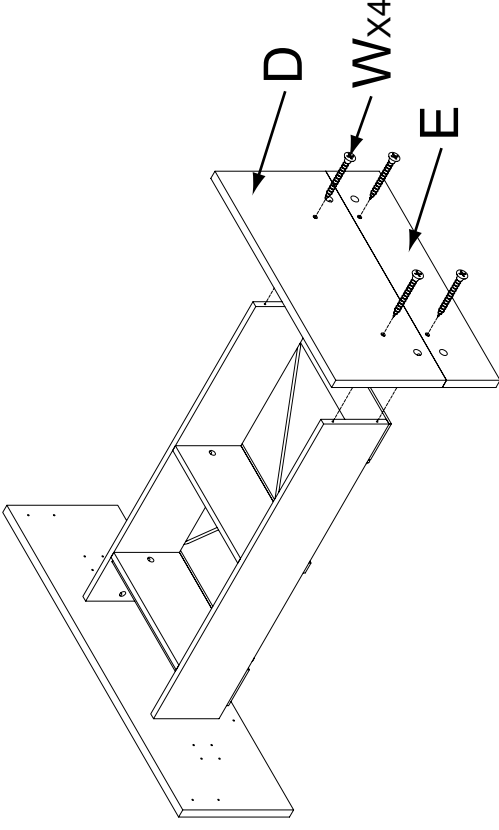

6- Fasten bottom board (D&E) to the body using screws (W).

6- Attachez le panneau inférieur (D&E) au corps à l'aide des vis (W).

6- Sujete el (D&E) del tablero inferior al cuerpo que usa los tornillos (W).

7

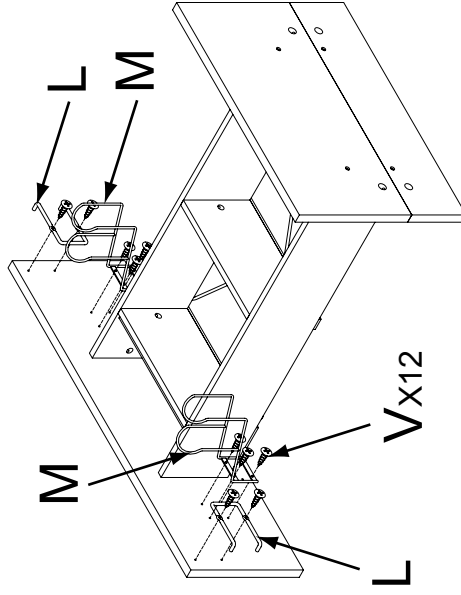

7- Fasten hanger (L&M) to the body using screws (V).

7- Attachez les supports (L&M) au corps à l'aide des vis (V).

7- Sujete los sostenedores (L&M) al cuerpo que usa los tornillos (V).

8

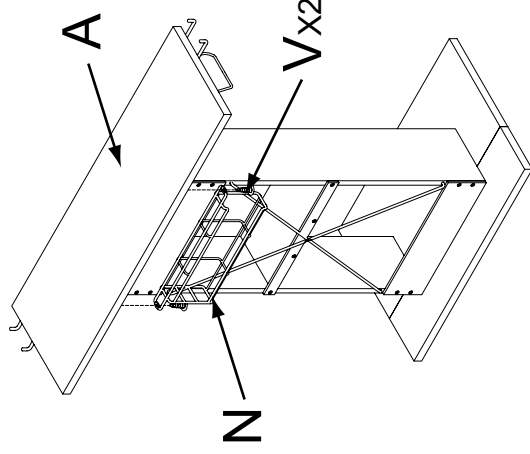

8-Fasten surge protector holder (N) to the panel (A) using screws (V).

8-Attachez support de protecteur de montée subite (N) au panneau (A) utilisant des vis (V).

8-Sujete sostenedor del protector de oleada (N) al panel (A) usando los tornillos (V).